

- All the product photos, color, parameters in this album are just for reference, we reserve the rights to modify their related data without unannounced notice. Any questions, please contact our service hotlines.
- The final interpretation for this album is reserved by our company.

**FOSHAN KOSOOM LIGHTING & ELECTRIC CO.,LTD.**

Add: Shunde District of Foshan City, Guangdong Province, Junan Town,  
Changxing Industrial Park, Changxing Road East, No. 8

Tel : +86-757-25519022 25514666

Fax: +86-757-25518966

Http://www.kosoom.com

E-mail:kosoom@kosoom.com



**KOSOOM**<sup>®</sup>  
Focus on Quality

**LED**  
INDOOR LIGHTING SYSTEM  
Product Catalog 2016-2017

[www.kosoom.com](http://www.kosoom.com)

## Company Profile

Devoting to developing the most advanced energy saving technology and pioneering in LED lighting solution industry is the ultimate goal to KOSOOM Lighting. Thanks to its specializing in R&D with a professional senior team which has more than 20 people, KOSOOM Lighting is able to keep pace with the most advanced LED lighting technology worldwide and became one of the leaders in China's LED lighting field.

Established in 2008, Now KOSOOM Lighting own two production base with more than 30000 square meters, 600 workers and 50 salesman is devoting to better KOSOOM future! We have more than 3 million pcs monthly production capacity currently, and it will increase to 5 million pcs per month within half year!

One pc of LED chip or PCB might be just one small element in a lighting fixture, but an important managing target for KOSOOM 's "Zero Defected Rate Management System".We adopting the strictest production procedure and management to ensure each single product produced by KOSOOM enjoys perfect quality and exceed customers' expectation.

Details-focused and professionalism is KOSOOM Lighting's character. We have been providing the most comprehensive and excellent lighting solution to customers from more than 30 countries overseas, enjoys a very high reputation, and becomes the first choice for many lighting projects.

Benefit maximizing for our customers, devoting to innovation and self-improved with our staffs is our operating principle. KOSOOM Lighting is aiming at being the first class company in LED field.





Kosoom Team

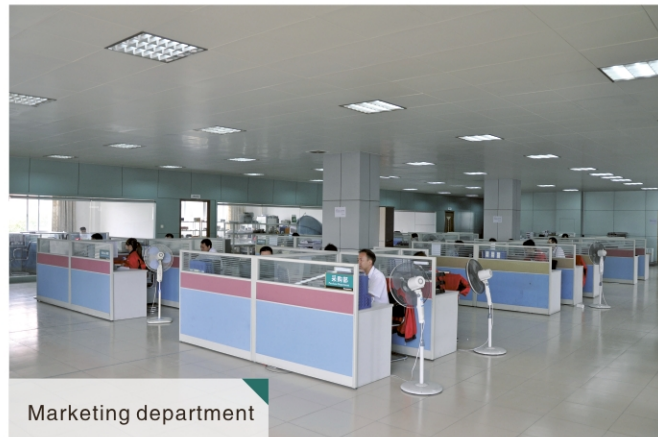

Marketing department



Administration department



Kosoom Man

Production Line



Auto insertion machine



Automatic SMT machine



Wave soldering



Aging line



Assembly line

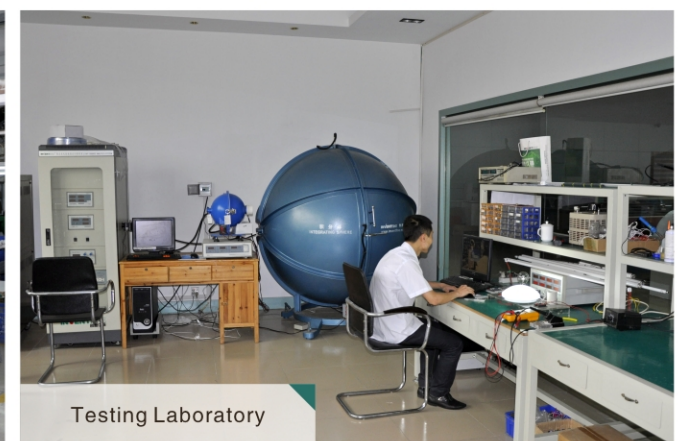

Testing Laboratory



# INDOOR LUMINARIES



Voltage Range:175-240V/100-240V  
 Frequency:50/60Hz  
 PF:0.5 or 0.9  
 CRI: RA>70 or RA>80  
 30000hrs Lifespan

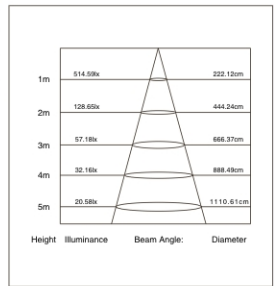
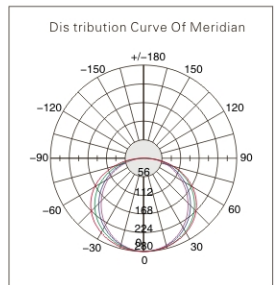

## EVEREST T5 BATTEN

MODEL CODE	POWER(W)	LUMEN(LM)	SIZE(MM)	LED QUANTITY	CARTON (MM)	PCS/CARTON
KST5E03004	4	390	311mm	22	370*210*165	30
KST5E06008	8	720	572mm	42	640*210*165	30
KST5E09012	12	1100	872mm	62	940*210*165	30
KST5E12016	16	1500	1172mm	84	1240*210*165	30
KST5E15022	22	2000	1472mm	110	1540*210*165	30



Voltage Range:175-240V/100-240V  
 Frequency:50/60Hz  
 PF:0.5 or 0.9  
 CRI: RA>70 or RA>80  
 30000hrs Lifespan

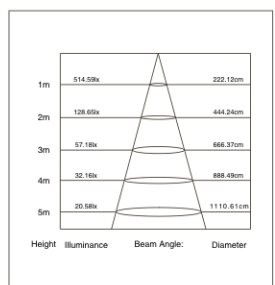
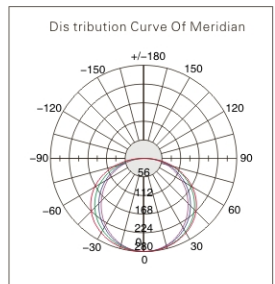

## DLUX T5 BATTEN

MODEL CODE	POWER(W)	LUMEN(LM)	SIZE(MM)	LED QUANTITY	CARTON (MM)	PCS/CARTON
KST5D03004	4	390	311mm	22	370*210*165	30
KST5D06008	8	720	572mm	42	640*210*165	30
KST5D09012	12	1100	872mm	62	940*210*165	30
KST5D12016	16	1500	1172mm	84	1240*210*165	30
KST5D15022	22	2000	1472mm	110	1540*210*165	30



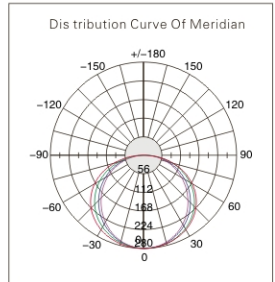

Voltage Range:175-240V/100-240V  
 Frequency:50/60Hz  
 PF:0.5 or 0.9  
 CRI: RA>70 or RA>80  
 30000hrs Lifespan

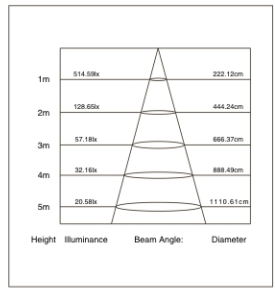

**HAPIX T5 BATTEN**

MODEL CODE	POWER(W)	LUMEN(LM)	SIZE(MM)	LED QUANTITY	CARTON (MM)	PCS/CARTON
KST5H03004	4	390	311mm	22	370*210*165	30
KST5H06008	8	720	572mm	42	640*210*165	30
KST5H09012	12	1100	872mm	62	940*210*165	30
KST5H12016	16	1500	1172mm	84	1240*210*165	30
KST5H15022	22	2000	1472mm	110	1540*210*165	30

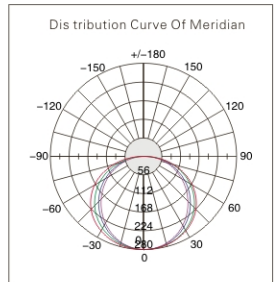

Voltage Range:175-240V/100-240V  
 Frequency:50/60Hz  
 PF:0.5 or 0.9  
 CRI: RA>70 or RA>80  
 30000hrs Lifespan

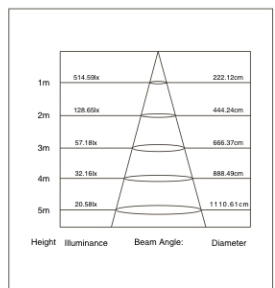

**FANTA T5 BATTEN**

MODEL CODE	POWER(W)	LUMEN(LM)	SIZE(MM)	LED QUANTITY	CARTON (MM)	PCS/CARTON
KST5F03004	4	390	311mm	22	370*210*165	30
KST5F06008	8	720	572mm	42	640*210*165	30
KST5F09012	12	1100	872mm	62	940*210*165	30
KST5F12016	16	1500	1172mm	84	1240*210*165	30
KST5F15022	22	2000	1472mm	110	1540*210*165	30

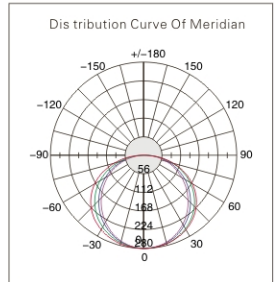

Voltage Range:175-240V/100-240V  
 Frequency:50/60Hz  
 PF:0.5 or 0.9  
 CRI: RA>70 or RA>80  
 30000hrs Lifespan

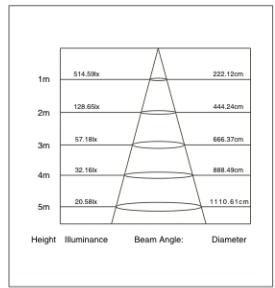

**PRADO T5 BATTEN**

MODEL CODE	POWER(W)	LUMEN(LM)	SIZE(MM)	LED QUANTITY	CARTON (MM)	PCS/CARTON
KST5P03004	4	390	311mm	22	370*210*165	30
KST5P06008	8	720	572mm	42	640*210*165	30
KST5P09012	12	1100	872mm	62	940*210*165	30
KST5P12016	16	1500	1172mm	84	1240*210*165	30
KST5P15022	22	2000	1472mm	110	1540*210*165	30

**Installation and Safety Instructions**

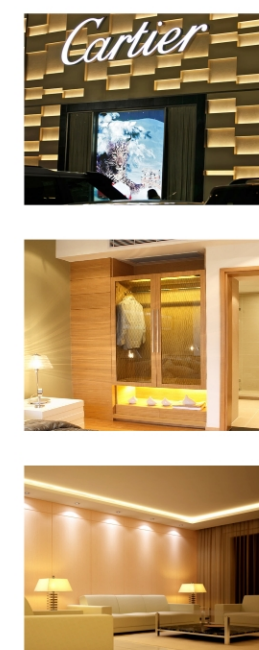

**Componets name and Installing introduction**

- For security and maintain, please consign the professional electric engineer to take charge of checking the lighting fixtures.
- The power of light source must be lower than the maximum rated power.
- Anytime, the light fixture can not be cover by heatproof gasket or similar material.
- Please do not install the lighting fixture can not above high-temperature objects and in moist places.
- There must be the intake of 75mm around the light fixture.
- Any abnormal phenomenon arises, please cut off the power and contact with the dealer at once.
- Please offer the type of the lighting fixture while maintain, and confirm the type according to the lamp body.

**Installation instruction**

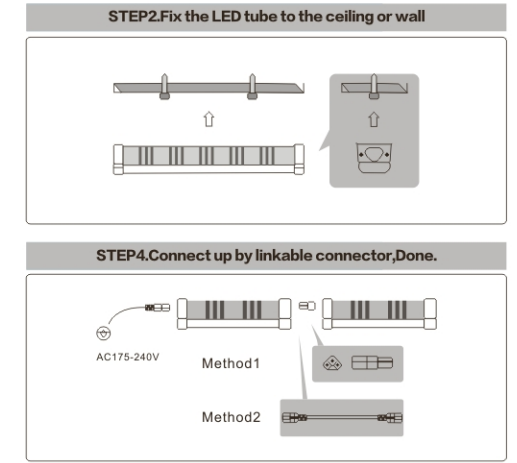
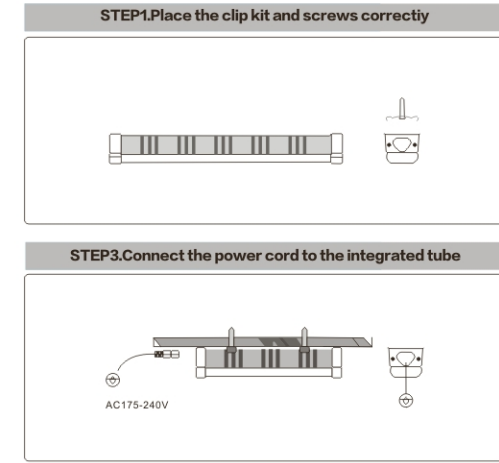

**Notice:**  
 Total Connection power less than 200W  
 Connection drawing

**Warning**  
 Do not transform the fixture, exchange the parts by yourself.





Voltage Range:100-300V  
Frequency:50/60Hz  
PF:0.9 2.5KV Surge protection  
CRI: RA>70 or RA>80  
30000hrs Lifespan



**GRACE T5 CENTRAL BATTEN**

MODEL CODE	POWER(W)	LUMEN(LM)	SIZE(MM)	LED QUANTITY	CARTON (MM)	PCS/CARTON
KST5GC03005	5	400	311mm	22	370*210*165	30
KST5GC06009	9	800	572mm	44	640*210*165	30
KST5GC12018	18	1600	1172mm	88	1240*210*165	30

**HUMVEE T5 CENTRAL BATTEN**

MODEL CODE	POWER(W)	LUMEN(LM)	SIZE(MM)	LED QUANTITY	CARTON (MM)	PCS/CARTON
KST5HC03005	5	400	311mm	22	370*210*165	30
KST5HC06009	9	800	572mm	44	640*210*165	30
KST5HC12018	18	1600	1172mm	88	1240*210*165	30

**SUCES T5 CENTRAL BATTEN**

MODEL CODE	POWER(W)	LUMEN(LM)	SIZE(MM)	LED QUANTITY	CARTON (MM)	PCS/CARTON
KST5SC03005	5	400	311mm	22	370*210*165	30
KST5SC06009	9	800	572mm	44	640*210*165	30
KST5SC12018	18	1600	1172mm	88	1240*210*165	30

**ROSS T5 CENTRAL BATTEN**

MODEL CODE	POWER(W)	LUMEN(LM)	SIZE(MM)	LED QUANTITY	CARTON (MM)	PCS/CARTON
KST5RC03005	5	400	311mm	22	370*210*165	30
KST5RC06009	9	800	572mm	44	640*210*165	30
KST5RC12018	18	1600	1172mm	88	1240*210*165	30



**PIROR T5 BATTEN**

MODEL CODE	POWER(W)	LUMEN(LM)	SIZE(MM)	LED QUANTITY	CARTON (MM)	PCS/CARTON
KST5PR03004	4	390	311mm	22	370*210*165	30
KST5PR06008	8	720	572mm	42	640*210*165	30
KST5PR09012	12	1100	872mm	62	940*210*165	30
KST5PR12016	16	1500	1172mm	84	1240*210*165	30



Voltage Range:175-240V/100-240V  
Frequency:50/60Hz  
PF:0.5 or 0.9  
CRI: RA>70 or RA>80  
30000hrs Lifespan

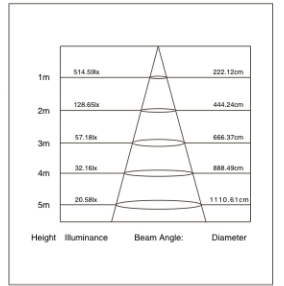
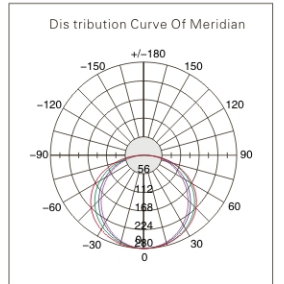

**TOUCHER T5 BATTEN**

MODEL CODE	POWER(W)	LUMEN(LM)	SIZE(MM)	LED QUANTITY	CARTON (MM)	PCS/CARTON
KST5TR03004	4	390	311mm	22	370*210*165	30
KST5TR06008	8	720	572mm	42	640*210*165	30
KST5TR09012	12	1100	872mm	62	940*210*165	30
KST5TR12016	16	1500	1172mm	84	1240*210*165	30

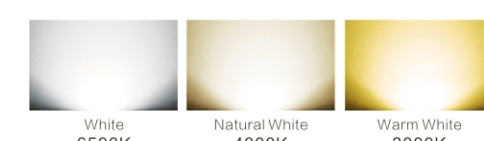

Voltage Range:175-240V/100-240V  
Frequency:50/60Hz  
PF:0.5 or 0.9  
CRI: RA>70 or RA>80  
30000hrs Lifespan

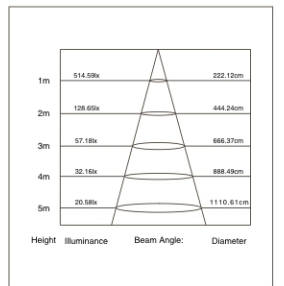
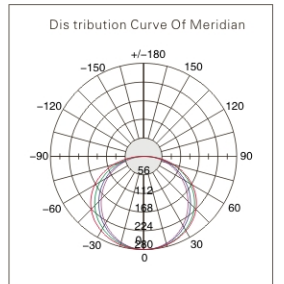



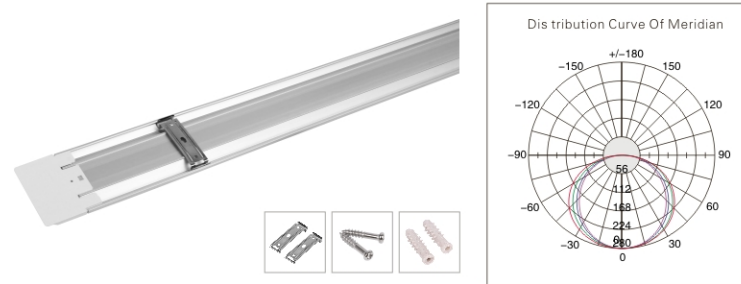

Voltage Range:175-240V/100-240V  
 Frequency:50/60Hz  
 PF:0.5 or 0.9  
 CRI: RA>70 or RA>80  
 30000hrs Lifespan

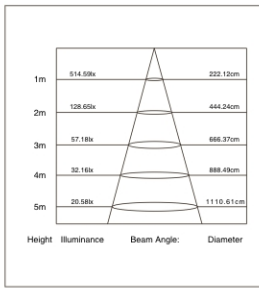

**PURIA WIDE TUBE**

MODEL CODE	POWER(W)	LUMEN(LM)	SIZE(MM)	LED QUANTITY	CARTON (MM)	PCS/CARTON
KSWTPA03009	9	760	300mm	42	340*180*430	25
KSWTPA06018	18	1500	600mm	84	640*180*430	25
KSWTPA09027	27	2300	900mm	126	940*180*430	25
KSWTPA12036	36	3000	1200mm	168	1250*180*430	25



Voltage Range:175-240V/100-240V  
 Frequency:50/60Hz  
 PF:0.5 or 0.9  
 CRI: RA>70 or RA>80  
 30000hrs Lifespan

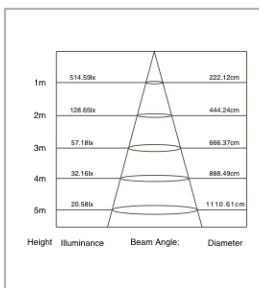

**ECOPU WIDE TUBE**

MODEL CODE	POWER(W)	LUMEN(LM)	SIZE(MM)	LED QUANTITY	CARTON (MM)	PCS/CARTON
KSWTEA03009	9	760	300mm	42	340*180*430	25
KSWTEA06018	18	1500	600mm	84	640*180*430	25
KSWTEA09027	27	2300	900mm	126	940*180*430	25
KSWTEA12036	36	3000	1200mm	168	1250*180*430	25

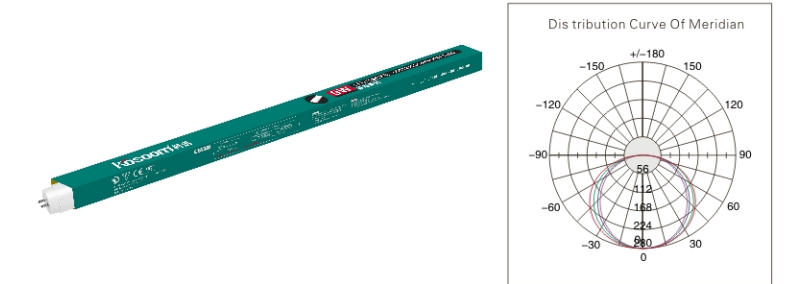

Voltage Range:175-240V/100-240V  
 Frequency:50/60Hz  
 PF:0.5 or 0.9  
 CRI: RA>70 or RA>80  
 30000hrs Lifespan

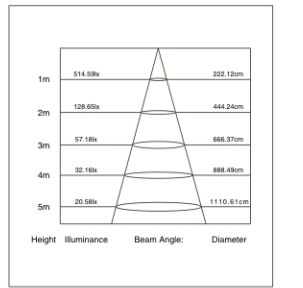

**GLASS T8**

MODEL CODE	POWER(W)	LUMEN(LM)	SIZE(MM)	LED QUANTITY	CARTON (MM)	PCS/CARTON
KST8EG06009	9	700	589	38	640*200*200	25
KST8EG12018	18	1400	1198	76	1240*200*200	25
KST8MG06009	9	900	589	42	640*200*200	25
KST8MG12018	18	1800	1198	84	1240*200*200	25
KST8SG06009	12	1100	589	48	640*200*200	25
KST8SG12018	24	2200	1198	96	1240*200*200	25

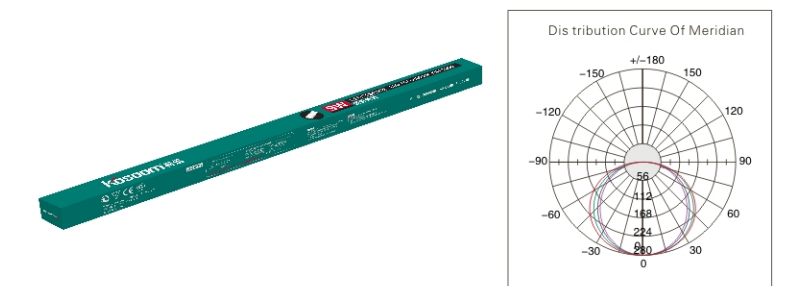

Voltage Range:175-240V/100-240V  
 Frequency:50/60Hz  
 PF:0.5 or 0.9  
 CRI: RA>70 or RA>80  
 30000hrs Lifespan

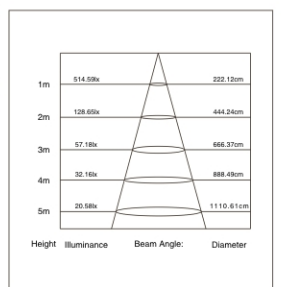

**POLO T8**

MODEL CODE	POWER(W)	LUMEN(LM)	SIZE(MM)	LED QUANTITY	CARTON (MM)	PCS/CARTON
KST8P06009	9	800	589	42	640*210*165	30
KST8P12018	18	1600	1198	84	1240*210*165	30





Voltage Range:175-240V/100-240V  
 Frequency:50/60Hz  
 PF:0.5 or 0.9  
 CRI: RA>70 or RA>80  
 30000hrs Lifespan  
**CLEAR COVER AVAILABLE**

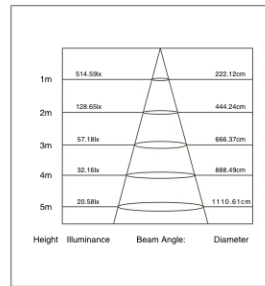
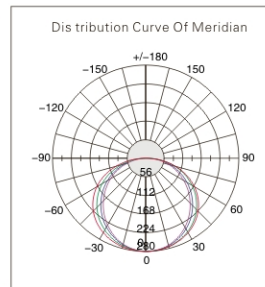

**ROYAL T8**

MODEL CODE	POWER(W)	LUMEN(LM)	SIZE(MM)	LED QUANTITY	CARTON (MM)	PCS/CARTON
KST8R06009	9	800	589	42	640*210*165	30
KST8R12018	18	1600	1198	84	1240*210*165	30
KST8RC06009	9	900	589	42	640*210*165	30
KST8RC12018	18	1800	1198	84	1240*210*165	30



Voltage Range:175-240V/100-240V  
 Frequency:50/60Hz  
 PF:0.5 or 0.9  
 CRI: RA>70 or RA>80  
 30000hrs Lifespan  
**CLEAR COVER AVAILABLE**

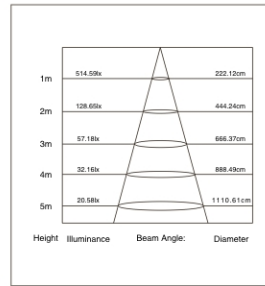
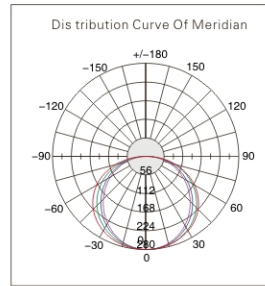

**OVAL T8**

MODEL CODE	POWER(W)	LUMEN(LM)	SIZE(MM)	LED QUANTITY	CARTON (MM)	PCS/CARTON
KST8O06009	9	800	589	42	640*210*165	30
KST8O12018	18	1600	1198	84	1240*210*165	30
KST8OC06009	9	900	589	42	640*210*165	30
KST8OC12018	18	1800	1198	84	1240*210*165	30



Voltage Range:175-240V/100-240V  
 Frequency:50/60Hz  
 PF:0.5 or 0.9  
 CRI: RA>70 or RA>80  
 30000hrs Lifespan  
**CLEAR COVER AVAILABLE**

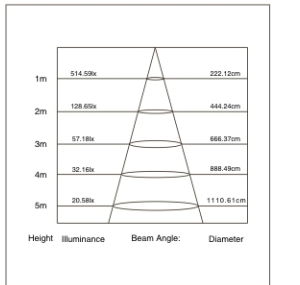
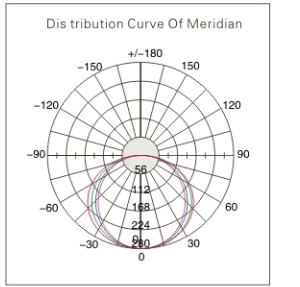

**LINKIN T8 BATTEN**

MODEL CODE	POWER(W)	LUMEN(LM)	SIZE(MM)	LED QUANTITY	CARTON (MM)	PCS/CARTON
KST8L06009	9	800	604	42	670*230*185	30
KST8L09014	14	1250	909	62	950*230*185	30
KST8L12018	18	1600	1205	84	1270*230*185	30
KST8LC06009	9	900	604	42	670*230*185	30
KST8LC09014	14	1400	909	62	950*230*185	30
KST8LC12018	18	1800	1205	84	1270*230*185	30



Voltage Range:175-240V/100-240V  
 Frequency:50/60Hz  
 PF:0.5 or 0.9  
 CRI: RA>70 or RA>80  
 30000hrs Lifespan  
**CLEAR COVER AVAILABLE**

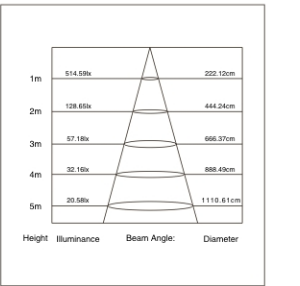
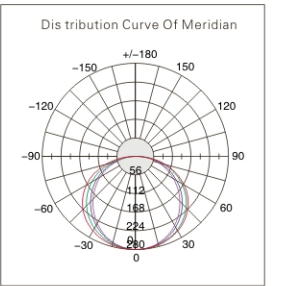

**SOLO T8 BATTEN**

MODEL CODE	POWER(W)	LUMEN(LM)	SIZE(MM)	LED QUANTITY	CARTON (MM)	PCS/CARTON
KST8S06009	9	850	604	42	670*230*185	30
KST8S09014	14	1300	909	62	950*230*185	30
KST8S12018	18	1700	1205	84	1270*230*185	30
KST8SC06009	9	1000	604	42	670*230*185	30
KST8SC09014	14	1500	909	62	950*230*185	30
KST8SC12018	18	1900	1205	84	1270*230*185	30



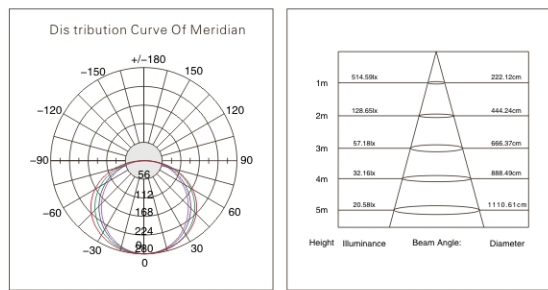

Voltage Range:175-240V/100-240V  
 Frequency:50/60Hz  
 PF:0.5 or 0.9  
 CRI: RA>70 or RA>80  
 30000hrs Lifespan

**VANA PROJECTOR**

MODEL CODE	POWER(W)	LUMEN(LM)	SIZE(MM)	LED QUANTITY	CARTON (MM)	PCS/CARTON
KSPTV12032	32	2400	1178*115*80	200	1200*260*170	6
KSPTV12064	64	4800	1178*115*80	400	1200*260*170	6

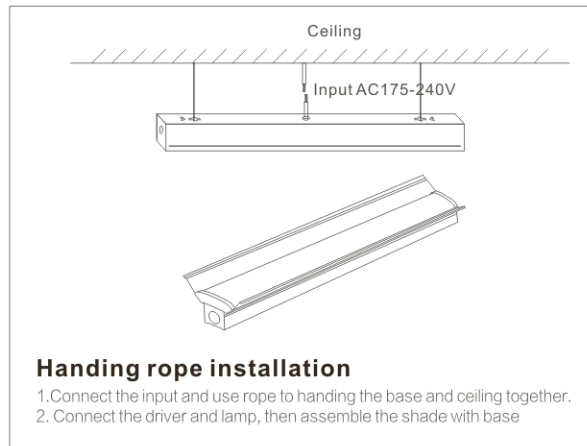
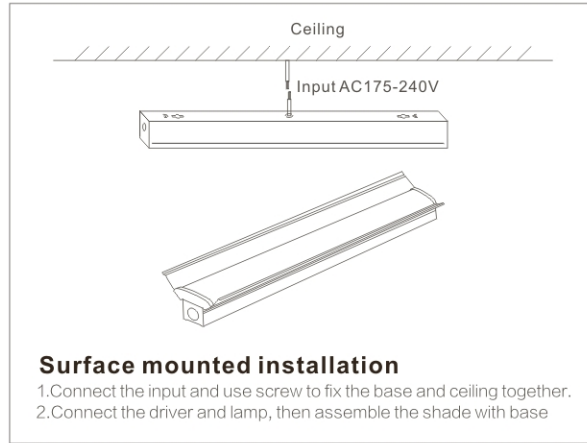

**Note:**

- 1.To avoid electric shock,Maintenance and installation should only be carried out by a profession electrician.
- 2.Before installation, Turn off the power to make sure safety.
- 3.Please install the fixture by above steps.
- 4.Please confirm the size of the lamp body before you cut-out.

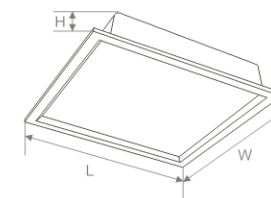
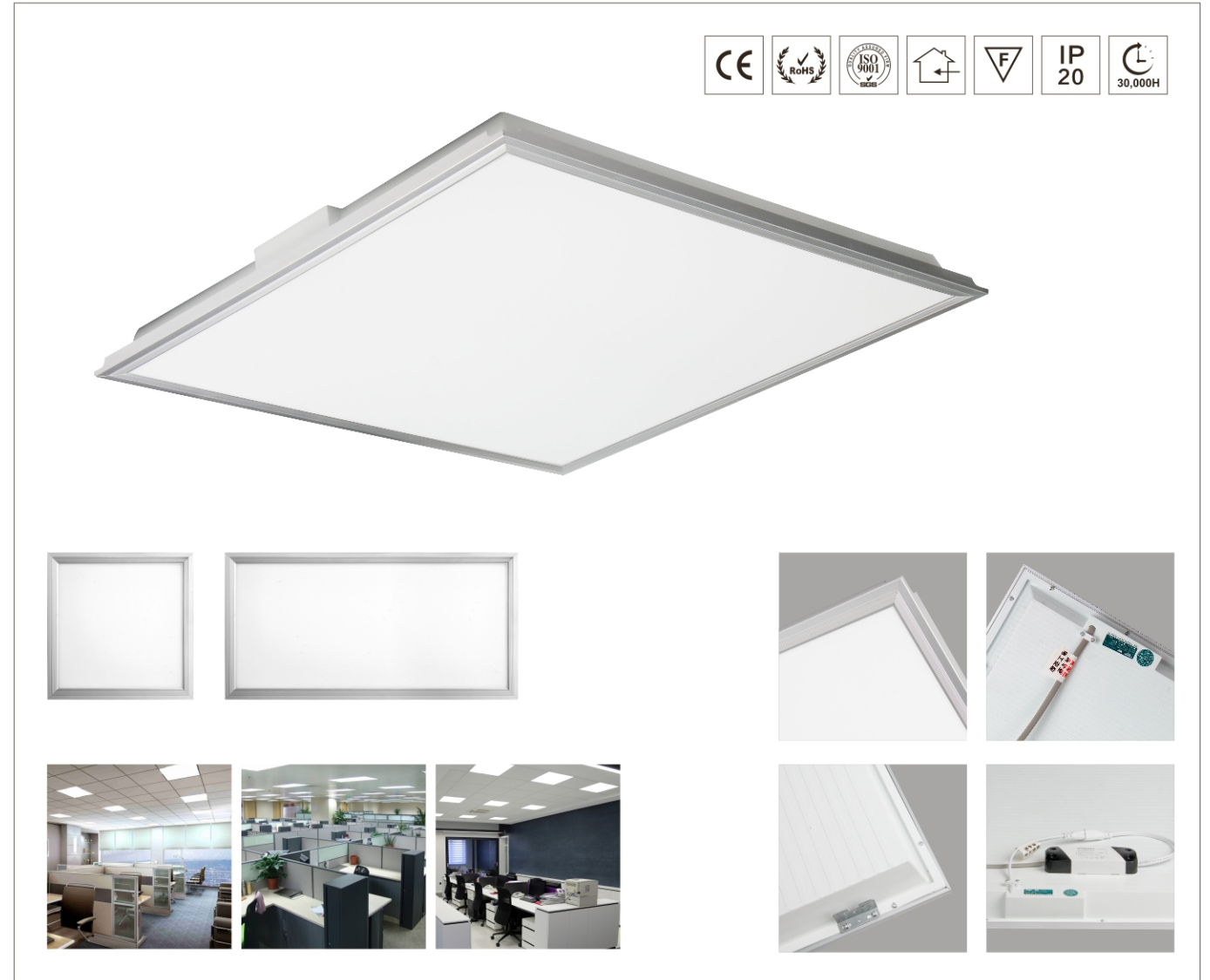

Voltage Range:175-240V/100-240V  
 Frequency:50/60Hz  
 PF:0.5 or 0.9  
 CRI: RA>70 or RA>80  
 30000hrs Lifespan

**INOVA PANEL**

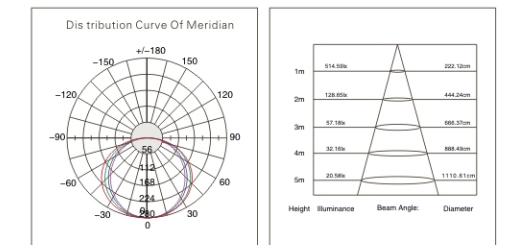

MODEL CODE	POWER(W)	LUMEN(LM)	SIZE(MM)	LED QUANTITY	CARTON (MM)	PCS/CARTON
KSPL303020	20	1800	295*295*43	100	520*315*315	10
KSPL306030	30	2700	295*595*43	150	630*485*315	10
KSPL606048	48	4000	595*595*43	288	630*220*630	4
KSPL3012048	48	4000	295*1195*43	360	1220*220*330	4





Voltage Range:175-240V  
 Frequency:50/60Hz  
 PF:0.5  
 CRI: RA>70 or RA>80  
 30000hrs Lifespan

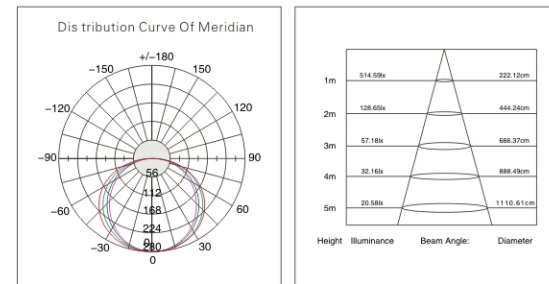
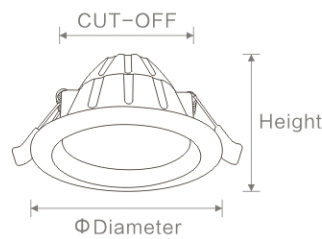

Voltage Range:175-240V/100-240V  
 Frequency:50/60Hz  
 PF:0.5 or 0.9  
 CRI: RA>70 or RA>80  
 30000hrs Lifespan

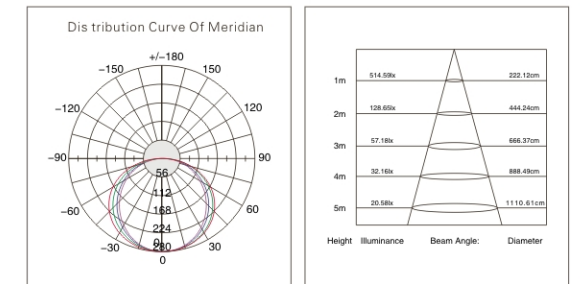
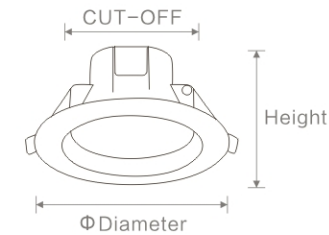

**SUPER DOWNLIGHT**

MODEL CODE	POWER(W)	LUMEN(LM)	SIZE(MM)	CUT-OFF(MM)	LED QUANTITY	CARTON (MM)	PCS/CARTON
KSDLSP06	6	400	Φ95*H51mm	Φ75mm	12	520*320*420	100
KSDLSP08	8	630	Φ120*H54mm	Φ90mm	16	645*320*265	50
KSDLSP10	10	810	Φ120*H54mm	Φ90mm	20	645*320*265	50
KSDLSP12	12	1080	Φ138*H54mm	Φ125mm	24	735*345*300	50
KSDLSP15	15	1350	Φ188*H72mm	Φ150mm	30	600*420*400	30
KSDLSP18	18	1620	Φ188*H72mm	Φ150mm	36	600*420*400	30

**SMART DOWNLIGHT**

MODEL CODE	POWER(W)	LUMEN(LM)	SIZE(MM)	CUT-OFF(MM)	LED QUANTITY	CARTON (MM)	PCS/CARTON
KSDLST05	5	400	Φ102x51.5	Φ75	11	570*320*460	100
KSDLST07	7	630	Φ102x51.6	Φ90~105	15	540*330*410	60
KSDLST09	9	810	Φ102x51.6	Φ90~105	20	540*330*410	60
KSDLST12	12	1080	Φ145x57.5	Φ125	26	470*345*315	30
KSDLST15	15	1350	Φ192x66.7	Φ150~170	32	620*395*415	30
KSDLST18	18	1620	Φ192x66.7	Φ150~170	38	620*395*415	30
KSDLST24	24	2160	Φ240x99	Φ200	50	510*510*525	20



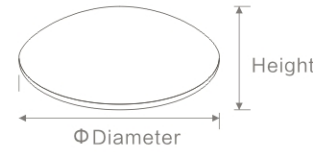

Voltage Range:175-240V/100-240V  
 Frequency:50/60Hz  
 PF:0.5 or 0.9  
 CRI: RA>70 or RA>80  
 30000hrs Lifespan

**LUNAR**

MODEL CODE	POWER(W)	LUMEN(LM)	SIZE(MM)	LED QUANTITY	CARTON (MM)	PCS/CARTON
KSCLLR10	10	800	190*100	50	470*450*235	10
KSCLLR14	14	1100	260*100	70	660*495*335	10
KSCLLR18	18	1500	300*100	90	800*570*405	10
KSCLLR22	22	1800	350*100	110	900*570*455	10

**PHONEIX**

MODEL CODE	POWER(W)	LUMEN(LM)	SIZE(MM)	LED QUANTITY	CARTON (MM)	PCS/CARTON
KSCLPX10	10	800	190*100	50	470*450*235	10
KSCLPX14	14	1100	260*100	70	660*495*335	10
KSCLPX18	18	1500	300*100	90	800*570*405	10
KSCLPX22	22	1800	350*100	110	900*570*455	10

**LILY**

MODEL CODE	POWER(W)	LUMEN(LM)	SIZE(MM)	LED QUANTITY	CARTON (MM)	PCS/CARTON
KSCLLY14	14	1100	260*100	70	660*495*335	10
KSCLLY18	18	1500	300*100	90	800*570*405	10
KSCLLY22	22	1800	350*100	110	900*570*455	10

**VINE**

MODEL CODE	POWER(W)	LUMEN(LM)	SIZE(MM)	LED QUANTITY	CARTON (MM)	PCS/CARTON
KSCLVN14	14	1100	260*100	70	660*495*335	10
KSCLVN18	18	1500	300*100	90	800*570*405	10
KSCLVN22	22	1800	350*100	110	900*570*455	10

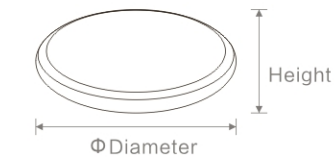

Voltage Range:175-240V/100-240V  
 Frequency:50/60Hz  
 PF:0.5 or 0.9  
 CRI: RA>70 or RA>80  
 30000hrs Lifespan

**HALO**

MODEL CODE	POWER(W)	LUMEN(LM)	SIZE(MM)	LED QUANTITY	CARTON (MM)	PCS/CARTON
KSCLHL14	14	1100	260*100	70	660*495*335	10
KSCLHL18	18	1500	300*100	90	800*570*405	10
KSCLHL22	22	1800	350*100	110	900*570*455	10

**BINARY STAR**

MODEL CODE	POWER(W)	LUMEN(LM)	SIZE(MM)	LED QUANTITY	CARTON (MM)	PCS/CARTON
KSCLBS14	14	1100	260*100	70	660*495*335	10
KSCLBS18	18	1500	300*100	90	800*570*405	10

**GALAXY**

MODEL CODE	POWER(W)	LUMEN(LM)	SIZE(MM)	LED QUANTITY	CARTON (MM)	PCS/CARTON
KSCLHL14	14	1100	260*100	70	660*495*335	10
KSCLHL18	18	1500	300*100	90	800*570*405	10
KSCLHL22	22	1800	350*100	110	900*570*455	10

**SPARKLE**

MODEL CODE	POWER(W)	LUMEN(LM)	SIZE(MM)	LED QUANTITY	CARTON (MM)	PCS/CARTON
KSCLHL14	14	1100	260*100	70	660*495*335	10
KSCLHL18	18	1500	300*100	90	800*570*405	10
KSCLHL22	22	1800	350*100	110	900*570*455	10

**SILVER MOON**

MODEL CODE	POWER(W)	LUMEN(LM)	SIZE(MM)	LED QUANTITY	CARTON (MM)	PCS/CARTON
KSCLHL14	14	1100	260*100	70	660*495*335	10
KSCLHL18	18	1500	300*100	90	800*570*405	10
KSCLHL22	22	1800	350*100	110	900*570*455	10



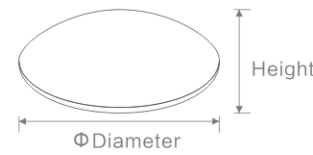

Voltage Range:175-240V/100-240V  
 Frequency:50/60Hz  
 PF:0.5 or 0.9  
 CRI: RA>70 or RA>80  
 30000hrs Lifespan



**SUPER PHONEIX**

MODEL CODE	POWER(W)	LUMEN(LM)	SIZE(MM)	LED QUANTITY	CARTON (MM)	PCS/CARTON
KSCLSPX12	12	1000	Φ275*H55	12	610*345*610	20
KSCLSPX18	18	1500	Φ345*H55	18	370*670*370	10
KSCLSPX24	24	2000	Φ405*H55	24	660*435*440	10
KSCLSPXDC18	18+18+28	1600	Φ405*H55	18	660*435*440	10



**SUPER LUNAR**

MODEL CODE	POWER(W)	LUMEN(LM)	SIZE(MM)	LED QUANTITY	CARTON (MM)	PCS/CARTON
KSCLSLR12	12	1000	Φ275*H55	12	610*345*610	20
KSCLSLR18	18	1500	Φ345*H55	18	370*670*370	10
KSCLSLR24	24	2000	Φ405*H55	24	660*435*440	10
KSCLSLRDC18	18+18+28	1600	Φ405*H55	18	660*435*440	10



**MOON**

MODEL CODE	POWER(W)	LUMEN(LM)	SIZE(MM)	LED QUANTITY	CARTON (MM)	PCS/CARTON
KSCLMON12	12	1000	Φ285*H45	12	335*500*335	8
KSCLMON18	18	1500	Φ375*H55	18	425*445*425	6
KSCLMON24	36	3000	Φ475*H65	36	520*320*520	4
KSCLMONDC25	25+25+39	2100	Φ475*H65	25	520*320*520	4



**SUPER MOON**

MODEL CODE	POWER(W)	LUMEN(LM)	SIZE(MM)	LED QUANTITY	CARTON (MM)	PCS/CARTON
KSCLSSM24	24	2000	Φ350*H70	24	400*660*400	8
KSCLSSM36	36	3000	Φ450*H70	36	500*500*500	6
KSCLSSM48	48	4000	Φ550*H70	48	600*340*600	4
KSCLSSMDC18	18+18+30	1600	Φ350*H70	18	400*660*400	8
KSCLSSMDC27	27+27+45	2400	Φ450*H70	27	500*500*500	6
KSCLSSMDC36	36+36+60	3200	Φ550*H70	36	600*340*600	4

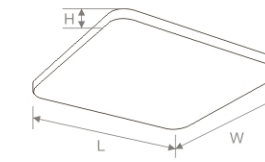

Voltage Range:175-240V/100-240V  
 Frequency:50/60Hz  
 PF:0.5 or 0.9  
 CRI: RA>70 or RA>80  
 30000hrs Lifespan



**SQUARE SILVER**

MODEL CODE	POWER(W)	LUMEN(LM)	SIZE(MM)	LED QUANTITY	CARTON (MM)	PCS/CARTON
KSCLSLV24	24	2000	340*340*65	24	400*660*400	8
KSCLSLV36	36	3000	440*440*65	36	500*500*500	6
KSCLSLV48	48	4000	540*540*65	48	600*340*600	4
KSCLSLVDC18	18+18+30	1600	340*340*65	18	400*660*400	8
KSCLSLVDC27	27+27+45	2400	440*440*65	27	500*500*500	6
KSCLSLVDC36	36+36+60	3200	540*540*65	36	600*340*600	4



**SLIDER**

MODEL CODE	POWER(W)	LUMEN(LM)	SIZE(MM)	LED QUANTITY	CARTON (MM)	PCS/CARTON
KSCLSLD24	24	2000	340*340*65	24	400*660*400	8
KSCLSLD36	36	3000	440*440*65	36	500*500*500	6
KSCLSLD48	48	4000	540*540*65	48	600*340*600	4
KSCLSLDDC18	18+18+30	1600	340*340*65	18	400*660*400	8
KSCLSLDDC27	27+27+45	2400	440*440*65	27	500*500*500	6
KSCLSLDDC36	36+36+60	3200	540*540*65	36	600*340*600	4



**SIDE WING**

MODEL CODE	POWER(W)	LUMEN(LM)	SIZE(MM)	LED QUANTITY	CARTON (MM)	PCS/CARTON
KSCLSDW24	24	2000	340*340*65	24	400*660*400	8
KSCLSDW36	36	3000	440*440*65	36	500*500*500	6
KSCLSDW48	48	4000	540*540*65	48	600*340*600	4
KSCLSDWDC18	18+18+30	1600	340*340*65	18	400*660*400	8
KSCLSDWDC27	27+27+45	2400	440*440*65	27	500*500*500	6
KSCLSDWDC36	36+36+60	3200	540*540*65	36	600*340*600	4





# LIGHT SOURCE

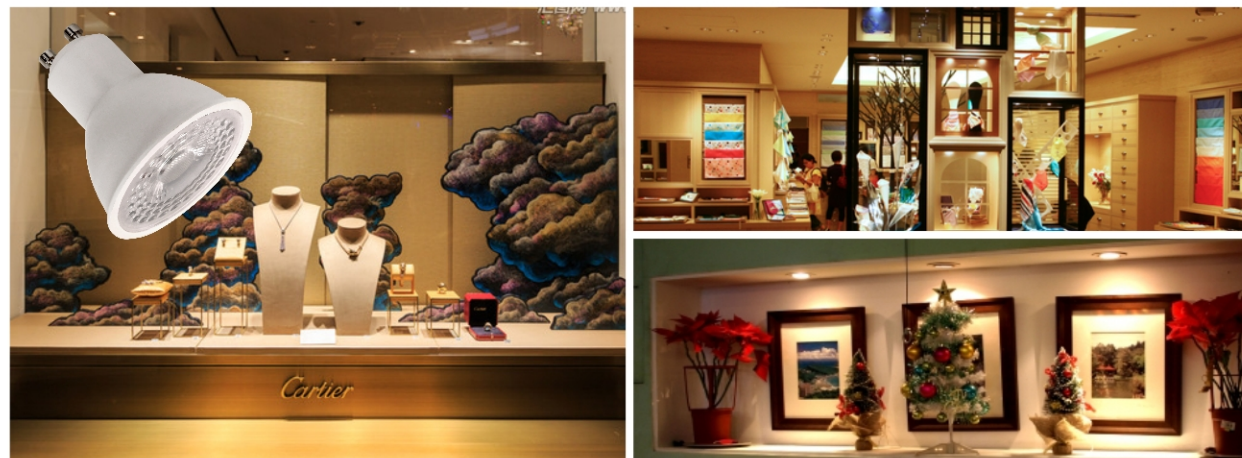

## APOLLO SERIES



Voltage Range:175-240V/100-240V  
 Frequency:50/60Hz  
 PF:0.5  
 CRI: RA>70 or RA>80  
 30000hrs Lifespan



MODEL CODE	POWER(W)	LUMEN(LM)	SIZE(MM)	LED QUANTITY	CARTON (MM)	PCS/CARTON
KSPA6005	5	400	60*110	10	620*320*240	100
KSPA6007	7	630	60*110	14	620*320*240	100
KSPA6009	9	810	60*110	18	620*320*240	100



Voltage Range:175-240V/100-240V  
 Frequency:50/60Hz  
 PF:0.5  
 CRI: RA>70 or RA>80  
 30000hrs Lifespan



MODEL CODE	POWER(W)	LUMEN(LM)	SIZE(MM)	LED QUANTITY	CARTON (MM)	PCS/CARTON
KSPA6011	11	1050	60*120	24	620*320*260	100



Voltage Range:175-240V/100-240V  
 Frequency:50/60Hz  
 PF:0.5  
 CRI: RA>70 or RA>80  
 30000hrs Lifespan



MODEL CODE	POWER(W)	LUMEN(LM)	SIZE(MM)	LED QUANTITY	CARTON (MM)	PCS/CARTON
KSPA7015	15	1350	70*130	30	370*370*280	50



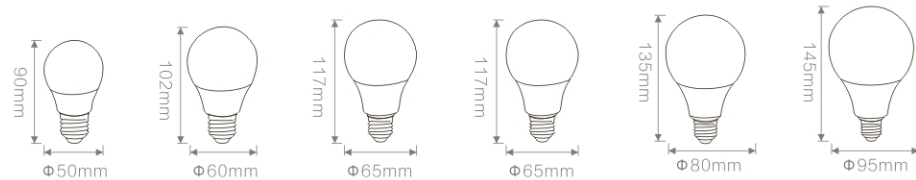

Voltage Range: 175-240V/100-240V  
 Frequency: 50/60Hz  
 PF: 0.5  
 CRI: RA>70 or RA>80  
 30000hrs Lifespan



**ARRIZO SERIES**

MODEL CODE	POWER(W)	LUMEN(LM)	SIZE(MM)	LED QUANTITY	CARTON (MM)	PCS/CARTON
KSRA5003	3	250	50*90	6	525*270*200	100
KSRA6005	5	450	60*102	10	620*320*220	100
KSRA6507	7	630	65*117	14	345*345*250	50
KSRA6509	9	810	65*117	18	345*345*250	50
KSRA8012	12	1050	80*135	24	420*420*290	50
KSRA9515	15	1300	95*145	30	510*510*355	50

**BOXER SERIES**

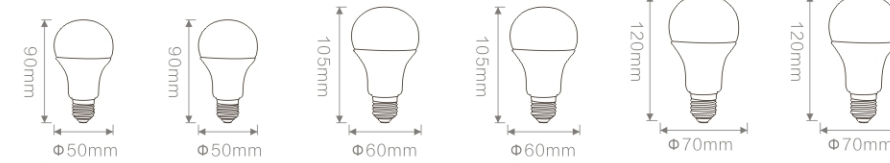

Voltage Range: 175-240V/100-240V  
 Frequency: 50/60Hz  
 PF: 0.5  
 CRI: RA>70 or RA>80  
 30000hrs Lifespan



MODEL CODE	POWER(W)	LUMEN(LM)	SIZE(MM)	LED QUANTITY	CARTON (MM)	PCS/CARTON
KSBA5003	3	250	50*90	6	525*270*200	100
KSBA5005	5	450	50*90	10	525*270*200	100



Voltage Range: 175-240V/100-240V  
 Frequency: 50/60Hz  
 PF: 0.5  
 CRI: RA>70 or RA>80  
 30000hrs Lifespan



MODEL CODE	POWER(W)	LUMEN(LM)	SIZE(MM)	LED QUANTITY	CARTON (MM)	PCS/CARTON
KSBA6007	7	630	60*105	14	620*320*220	100
KSBA6009	9	810	60*105	18	620*320*220	100



Voltage Range: 175-240V/100-240V  
 Frequency: 50/60Hz  
 PF: 0.5  
 CRI: RA>70 or RA>80  
 30000hrs Lifespan



MODEL CODE	POWER(W)	LUMEN(LM)	SIZE(MM)	LED QUANTITY	CARTON (MM)	PCS/CARTON
KSBA7012	12	1050	70*120	24	370*370*260	50
KSBA7015	15	1300	70*120	30	370*370*260	50





### GOLF BULB



Voltage Range:175-240V/100-240V  
 Frequency:50/60Hz  
 PF:0.5  
 CRI: RA>70 or RA>80  
 30000hrs Lifespan



MODEL CODE	POWER(W)	LUMEN(LM)	SIZE(MM)	LED QUANTITY	CARTON (MM)	PCS/CARTON
KSG4503	3	250	45*80	6	470*245*200	100
KSG4505	5	400	45*80	10	470*245*200	100
KSG4507	7	600	45*80	14	470*245*200	100
KSP4503	3	250	45*85	6	470*245*200	100
KSP4505	5	400	45*85	10	470*245*200	100
KSP4507	7	600	45*85	14	470*245*200	100

### CANDLE BULB



Voltage Range:175-240V/100-240V  
 Frequency:50/60Hz  
 PF:0.5  
 CRI: RA>70 or RA>80  
 30000hrs Lifespan



MODEL CODE	POWER(W)	LUMEN(LM)	SIZE(MM)	LED QUANTITY	CARTON (MM)	PCS/CARTON
KSC3703	3	250	37*110	6	390*205*240	100
KSC3705	5	400	37*110	10	390*205*240	100
KSC3707	7	600	37*110	14	390*205*240	100
KSCA3703	3	250	37*113	6	390*205*240	100
KSCA3705	5	400	37*113	10	390*205*240	100
KSCA3707	7	600	37*113	14	390*205*240	100
KSC37L03	3	250	37*115	6	390*205*250	100
KSC37L05	5	400	37*115	10	390*205*250	100
KSC37L07	7	600	37*115	14	390*205*250	100
KSCA37L03	3	250	37*118	6	390*205*250	100
KSCA37L05	5	400	37*118	10	390*205*250	100
KSCA37L07	7	600	37*118	14	390*205*250	100

### DIAMOND CANDLE



Voltage Range:175-240V/100-240V  
 Frequency:50/60Hz  
 PF:0.5  
 CRI: RA>70 or RA>80  
 30000hrs Lifespan



MODEL CODE	POWER(W)	LUMEN(LM)	SIZE(MM)	LED QUANTITY	CARTON (MM)	PCS/CARTON
KSCD3703	3	200	37*110	6	390*205*240	100
KSCD3705	5	350	37*110	10	390*205*240	100
KSCDL3703	3	200	37*110	6	390*205*240	100
KSCDL3705	5	350	37*110	10	390*205*240	100



18W

24W

36W

50W

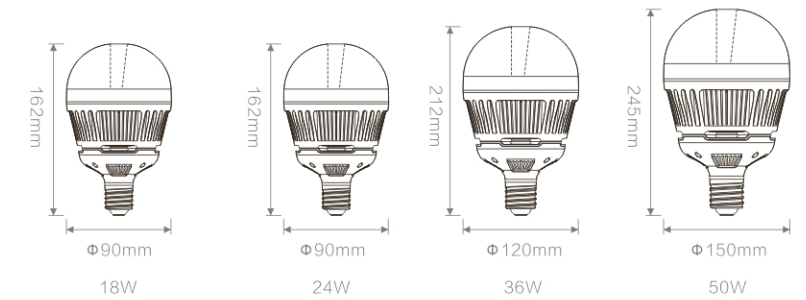

Voltage Range:175-240V/100-240V  
 Frequency:50/60Hz  
 PF:0.5 or 0.9  
 CRI: RA>70 or RA>80  
 30000hrs Lifespan



### TORCH BULB

MODEL CODE	POWER(W)	LUMEN(LM)	SIZE(MM)	LED QUANTITY	CARTON (MM)	PCS/CARTON
KSTB09018	18	1550	90*162	18	470*280*350	30
KSTB09024	24	2000	90*162	24	470*280*350	30
KSTB12036	36	3000	120*212	36	620*380*450	30
KSTB15048	48	4000	150*245	50	770*315*260	10



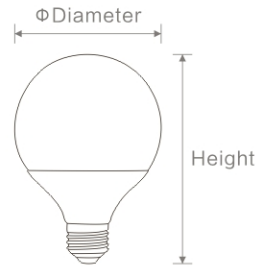

Voltage Range:175-240V/100-240V  
 Frequency:50/60Hz  
 PF:0.5 or 0.9  
 CRI: RA>70 or RA>80  
 30000hrs Lifespan



**GLOBE BULB**

MODEL CODE	POWER(W)	LUMEN(LM)	SIZE(MM)	LED QUANTITY	CARTON (MM)	PCS/CARTON
KSG9515	15	1350	95*135	30	510*510*290	50
KSG12018	18	1600	120*150	36	620*620*320	50



Voltage Range:175-240V/100-240V  
 Frequency:50/60Hz  
 PF:0.5 or 0.9  
 CRI: RA>70 or RA>80  
 30000hrs Lifespan



**UFO LIGHT**

MODEL CODE	POWER(W)	LUMEN(LM)	SIZE(MM)	LED QUANTITY	CARTON (MM)	PCS/CARTON
KSUFO10008	8	640	100*75	16	545*395*440	100
KSUFO15016	16	1250	150*85	80	485*445*330	30
KSUFO23023	23	1900	230*90	120	490*470*490	20



Voltage Range:175-240V/100-240V  
 Frequency:50/60Hz  
 PF:0.5  
 CRI: RA>70 or RA>80  
 30000hrs Lifespan



**REFLECTOR**

MODEL CODE	POWER(W)	LUMEN(LM)	SIZE(MM)	LED QUANTITY	CARTON (MM)	PCS/CARTON
KSR3903	3	200	39*67	6	215*355*335	200
KSR5005	5	400	50*85	10	220*445*270	100
KSR6306	6.5	500	63*100	13	270*520*335	100
KSR6308	8	650	63*100	16	270*520*335	100
KSR8010	10	810	80*114	20	420*420*250	50



**SMD GU10**



Voltage Range:175-240V/100-240V  
 Frequency:50/60Hz  
 PF:0.5 or 0.9  
 CRI: RA>70 or RA>80  
 30000hrs Lifespan



MODEL CODE	POWER(W)	LUMEN(LM)	SIZE(MM)	LED QUANTITY	CARTON (MM)	PCS/CARTON
KSGU10S03	3	200	50*52	6	270*280*420	200
KSGU10S05	5	400	50*52	10	270*280*420	200
KSGU10S07	6.5	500	50*52	14	270*280*420	200
KSGU10S08	7.5	650	50*52	16	270*280*420	200

**COB GU10**



Voltage Range:175-240V/100-240V  
 Frequency:50/60Hz  
 PF:0.5 or 0.9  
 CRI: RA>70 or RA>80  
 30000hrs Lifespan



MODEL CODE	POWER(W)	LUMEN(LM)	SIZE(MM)	LED QUANTITY	CARTON (MM)	PCS/CARTON
KSGU10C03	3	200	50*52	24/36	270*280*420	200
KSGU10C05	5	400	50*52	24/36	270*280*420	200
KSGU10C07	6.5	500	50*52	24/36	270*280*420	200

**SMD MR16**



Voltage Range:175-240V/100-240V  
 Frequency:50/60Hz  
 PF:0.5 or 0.9  
 CRI: RA>70 or RA>80  
 30000hrs Lifespan



MODEL CODE	POWER(W)	LUMEN(LM)	SIZE(MM)	LED QUANTITY	CARTON (MM)	PCS/CARTON
KSMR16S03	3	200	50*48	6	270*260*420	200
KSMR16S05	5	400	50*48	10	270*260*420	200
KSMR16S07	6.5	500	50*48	14	270*260*420	200
KSMR16S08	7.5	650	50*48	16	270*260*420	200

**COB MR16**



Voltage Range:175-240V/100-240V  
 Frequency:50/60Hz  
 PF:0.5 or 0.9  
 CRI: RA>70 or RA>80  
 30000hrs Lifespan



MODEL CODE	POWER(W)	LUMEN(LM)	SIZE(MM)	BEAN ANGLE	CARTON (MM)	PCS/CARTON
KSMR16C03	3	200	50*48	24/36	270*260*420	200
KSMR16C05	5	400	50*48	24/36	270*260*420	200
KSMR16C07	6.5	500	50*48	24/36	270*260*420	200

**SHOP LIGHTING**







Applicable to single lamp dimming system

**TLA TRACK**

Voltage Range:175-240V/100-240V  
 Frequency:50/60Hz  
 PF:0.9  
 CRI: RA>83  
 30000hrs Lifespan

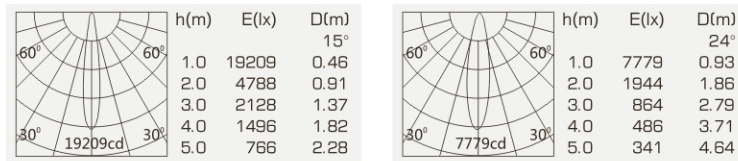

MODEL CODE	POWER(W)	BEAN ANGLE	SIZE(MM)	CREE COB
KSTLA1801	18	15/24/36	Φ71*97	1512
KSTLA1802	18	15/24/36	Φ78*104	1512
KSTLA3001	30	15/24/36	Φ92*118	1816
KSTLA4201	42	15/24/36	Φ106*131	1830

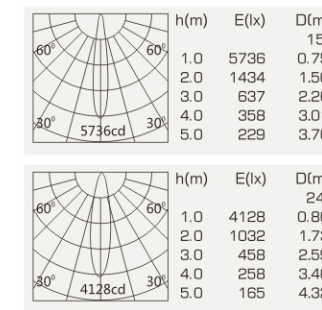

**TLB TRACK**

Voltage Range:175-240V/100-240V  
 Frequency:50/60Hz  
 PF:0.9  
 CRI: RA>83  
 30000hrs Lifespan



Lens

MODEL CODE	POWER(W)	BEAN ANGLE	SIZE(MM)	CREE COB
KSTLB2401	24	15/24	Φ78*147	1512
KSTLB3601	36	15/24	Φ100*179	1820

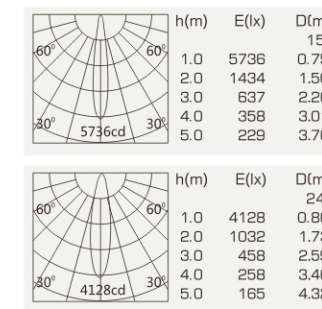
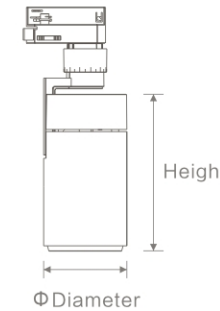

**TLC TRACK**

Voltage Range:175-240V/100-240V  
 Frequency:50/60Hz  
 PF:0.9  
 CRI: RA>83  
 30000hrs Lifespan



Lens

MODEL CODE	POWER(W)	BEAN ANGLE	SIZE(MM)	CREE COB
KSTLC1201	12	15/24	Φ56*175	1507
KSTLC1801	18	15/24	Φ69*195	1512

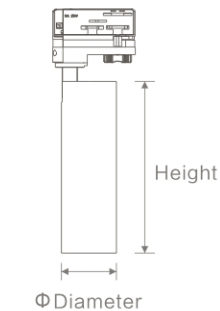





**RECESS TRACK LIGHT**

Voltage Range:175-240V/100-240V  
 Frequency:50/60Hz  
 PF:0.9  
 CRI: RA>83  
 30000hrs Lifespan

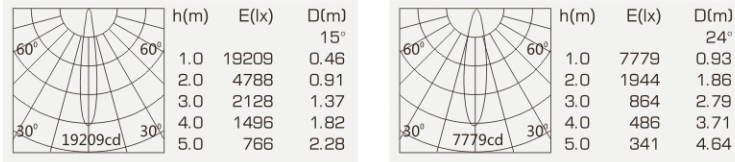

MODEL CODE	POWER(W)	BEAN ANGLE	SIZE(MM)	CREE COB
KSRTL3601	36	15/24	Φ150*144	1820
KSRTL4201	42	15/24	Φ150*144	1830
KSSTL3601	36	15/24	150*150*163	1820
KSSTL4201	42	15/24	150*150*163	1830

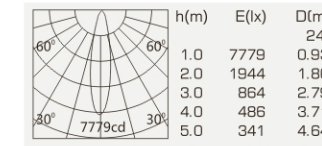
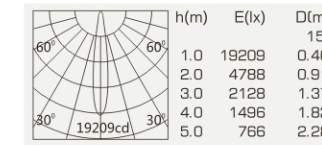

**ROUND SPOT LIGHT**

Voltage Range:175-240V/100-240V  
 Frequency:50/60Hz  
 PF:0.9  
 CRI: RA>83  
 30000hrs Lifespan

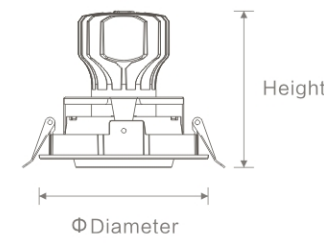

MODEL CODE	POWER(W)	BEAN ANGLE	SIZE(MM)	CREE COB
KSRS1801	18	15/24	Φ120*111	1512
KSRS13001	30	15/24	Φ120*122	1816
KSRS13002	30	15/24	Φ150*138	1816
KSRS14201	42	15/24	Φ150*155	1830

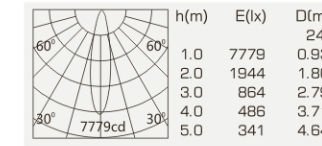
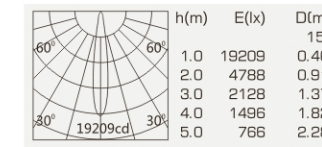

**SQUARE SPOT LIGHT**

Voltage Range:175-240V/100-240V  
 Frequency:50/60Hz  
 PF:0.9  
 CRI: RA>83  
 30000hrs Lifespan

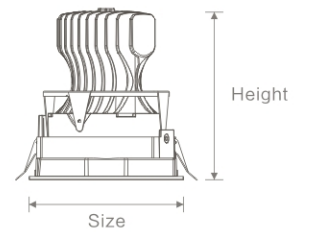

MODEL CODE	POWER(W)	BEAN ANGLE	SIZE(MM)	CREE COB
KSSSL1801	18	15/24	120*120*120	1512
KSSSL3001	30	15/24	120*120*130	1816
KSSSL3002	30	15/24	150*150*150	1816
KSSSL4201	42	15/24	150*150*166	1830





**Notes:**

---

---

---

---

---

---

---

---

---

---

---

---

---

---

---

---

---

---

---

---

---

---

---

---

---

---

---

---

---

---



For Further Information, Please Explore Our Website  
Or Follow Our Wechat Public Account

[Http://www.kosoom.com](http://www.kosoom.com)

